

## Low-Cost, CMOS, Rail-to-Rail, I/O OPERATIONAL AMPLIFIERS

### FEATURES

- RAIL-TO-RAIL INPUT AND OUTPUT
- WIDE SUPPLY RANGE:  
Single Supply: 4V to 12V  
Dual Supplies:  $\pm 2$  to  $\pm 6$
- LOW QUIESCENT CURRENT: 160 $\mu$ A
- LIMITED RANGE CMRR: 96dB
- LOW OFFSET: 0.5mV
- HIGH SPEED: 1MHz, 0.6V/ $\mu$ s
- *Micro*SIZE PACKAGES:  
SOT23-5, MSOP-8, TSSOP-14
- LOW INPUT BIAS CURRENT: 1pA

### APPLICATIONS

- AUTOMOTIVE APPLICATIONS:  
Audio, Sensor Applications, Security Systems
- PORTABLE EQUIPMENT
- ACTIVE FILTERS
- TRANSDUCER AMPLIFIER
- TEST EQUIPMENT
- DATA ACQUISITION

### DESCRIPTION

The OPA705 series low-cost op amps are optimized for applications requiring rail-to-rail input and output swing. Single, dual, and quad versions are offered in a variety of packages. While the quiescent current is less than 200 $\mu$ A per amplifier, the OPA705 still offers excellent dynamic performance (1MHz GBW and 0.6V/ $\mu$ s SR) and unity-gain stability.

The OPA705 series is fully specified and guaranteed over the supply range of  $\pm 2$ V to  $\pm 6$ V. Input swing extends 300mV beyond the rail and the output swings to within 40mV of the rail.

The single version (OPA705) is available in the *Micro*SIZE SOT23-5 and in the standard SO-8 surface-mount packages. The dual version (OPA2705) is available in the MSOP-8, SO-8, and DIP-8 packages. The quad OPA4705 is available in the TSSOP-14 and SO-14 packages. All are specified for operation from  $-40^{\circ}$ C to  $+85^{\circ}$ C.

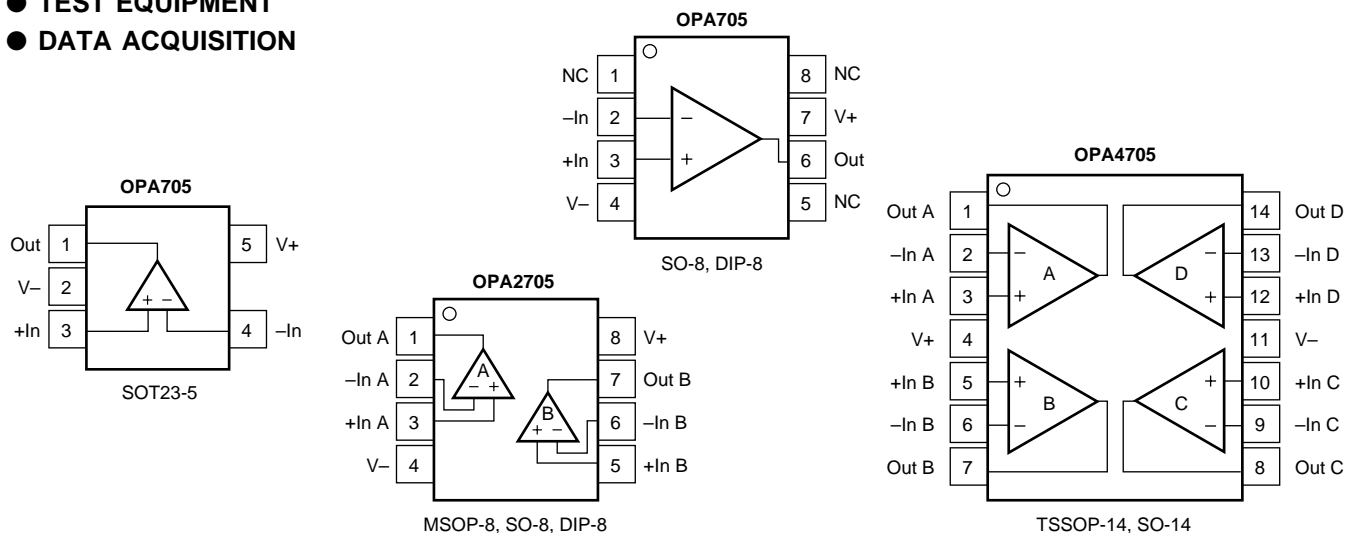

Please be aware that an important notice concerning availability, standard warranty, and use in critical applications of Texas Instruments semiconductor products and disclaimers thereto appears at the end of this data sheet.

## ABSOLUTE MAXIMUM RATINGS<sup>(1)</sup>

Supply Voltage, V+ to V-.....	13.2V
Signal Input Terminals, Voltage <sup>(2)</sup> ..... (V-) -0.3V to (V+) +0.3V	
Current <sup>(2)</sup> .....	10mA
Output Short-Circuit <sup>(3)</sup> .....	Continuous
Operating Temperature.....	-55°C to +125°C
Storage Temperature.....	-65°C to +150°C
Junction Temperature.....	+150°C
Lead Temperature (soldering, 10s).....	+300°C

NOTES: (1) Stresses above these ratings may cause permanent damage. Exposure to absolute maximum conditions for extended periods may degrade device reliability. (2) Input terminals are diode-clamped to the power supply rails. Input signals that can swing more than 0.3V beyond the supply rails should be current-limited to 10mA or less. (3) Short-circuit to ground, one amplifier per package.



## ELECTROSTATIC DISCHARGE SENSITIVITY

This integrated circuit can be damaged by ESD. Texas Instruments recommends that all integrated circuits be handled with appropriate precautions. Failure to observe proper handling and installation procedures can cause damage.

ESD damage can range from subtle performance degradation to complete device failure. Precision integrated circuits may be more susceptible to damage because very small parametric changes could cause the device not to meet its published specifications.

## PACKAGE/ORDERING INFORMATION

PRODUCT	DESCRIPTION	MINIMUM RECOMMENDED GAIN	PACKAGE	PACKAGE DRAWING NUMBER	PACKAGE MARKING	ORDERING NUMBER <sup>(1)</sup>	TRANSPORT MEDIA
OPA705NA	Single, GBW = 1MHz	1	SOT23-5	331	A05	OPA705NA/250	Tape and Reel
"	"	"	"	"	"	OPA705NA/3K	Tape and Reel
OPA705UA	Single, GBW = 1MHz	1	SO-8	182	OPA705UA	OPA705UA	Rails
"	"	"	"	"	"	OPA705UA/2K5	Tape and Reel
OPA705PA	Single, GBW = 1MHz	1	DIP-8	006	OPA705PA	OPA705PA	Rails
OPA2705EA	Dual, GBW = 1MHz	1	MSOP-8	337	B05	OPA2705EA/250	Tape and Reel
"	"	"	"	"	"	OPA2705EA/2K5	Tape and Reel
OPA2705UA	Dual, GBW = 1MHz	1	SO-8	182	OPA2705UA	OPA2705UA	Rails
"	"	"	"	"	"	OPA2705UA/2K5	Tape and Reel
OPA2705PA	Dual, GBW = 1MHz	1	DIP-8	006	OPA2705PA	OPA2705PA	Rails
OPA4705EA	Quad, GBW = 1MHz	1	TSSOP-14	357	OPA4705EA	OPA4705EA/250	Tape and Reel
"	"	"	"	"	"	OPA4705EA/2K5	Tape and Reel
OPA4705UA	Quad, GBW = 1MHz	1	SO-14	235	OPA4705UA	OPA4705UA	Rails
"	"	"	"	"	"	OPA4705UA/2K5	Tape and Reel

NOTE: (1) Models with a slash (/) are available only in Tape and Reel in the quantities indicated (e.g., /3K indicates 3000 devices per reel). Ordering 3000 pieces of "OPA705NA/3K" will get a single 3000-piece Tape and Reel.

# ELECTRICAL CHARACTERISTICS: $V_S = 4V$ to $12V$

**Boldface** limits apply over the specified temperature range,  $T_A = -40^\circ\text{C}$  to  $+85^\circ\text{C}$

At  $T_A = +25^\circ\text{C}$ ,  $R_L = 20\text{k}\Omega$  connected to  $V_S/2$  and  $V_{OUT} = V_S/2$ , unless otherwise noted.

PARAMETER	CONDITION	OPA705NA, UA, PA OPA2705EA, UA, PA OPA4705EA, UA			UNITS
		MIN	TYP	MAX	
<b>OFFSET VOLTAGE</b> Input Offset Voltage <b>Drift</b> vs Power Supply <b>Over Temperature</b> Channel Separation, dc $f = 1\text{kHz}$	$V_{OS}$ $dV_{OS}/dT$ PSRR $V_S = \pm 5V, V_{CM} = 0V$ $T_A = -40^\circ\text{C}$ to $+85^\circ\text{C}$ $V_S = \pm 2V$ to $\pm 6V, V_{CM} = 0V$ $V_S = \pm 2V$ to $\pm 6V, V_{CM} = 0V$ $R_L = 20\text{k}\Omega$		$\pm 0.5$ $\pm 4$ 20 <b>100</b> 1 98	$\pm 5$  100	mV $\mu\text{V}/^\circ\text{C}$ $\mu\text{V}/\text{V}$ $\mu\text{V}/\text{V}$ $\mu\text{V}/\text{V}$ dB
<b>INPUT VOLTAGE RANGE</b> Common-Mode Voltage Range Common-Mode Rejection Ratio <b>over Temperature</b>	$V_{CM}$ CMRR $V_S = \pm 5V, (V-) - 0.3V < V_{CM} < (V+) + 0.3V$ $V_S = \pm 5V, (V-) < V_{CM} < (V+)$ $V_S = \pm 5V, (V-) - 0.3V < V_{CM} < (V+) - 2V$ $V_S = \pm 5V, (V-) < V_{CM} < (V+) - 2V$	$(V-) - 0.3$ 66 66	77 <b>74</b> 96 <b>93</b>	$(V+) + 0.3$	V dB dB dB
<b>INPUT BIAS CURRENT</b> Input Bias Current Input Offset Current	$I_B$ $I_{OS}$ $V_S = \pm 5V, V_{CM} = 0V$ $V_S = \pm 5V, V_{CM} = 0V$		$\pm 1$ $\pm 0.5$	$\pm 10$ $\pm 10$	pA pA
<b>INPUT IMPEDANCE</b> Differential Common-Mode			$4 \cdot 10^9 \parallel 4$ $5 \cdot 10^{12} \parallel 4$		$\Omega \parallel \text{pF}$ $\Omega \parallel \text{pF}$
<b>NOISE</b> Input Voltage Noise, $f = 0.1\text{Hz}$ to $10\text{Hz}$ Input Voltage Noise Density, $f = 1\text{kHz}$ Current Noise Density, $f = 1\text{kHz}$	$e_n$ $i_n$ $V_S = \pm 5V, V_{CM} = 0V$ $V_S = \pm 5V, V_{CM} = 0V$ $V_S = \pm 5V, V_{CM} = 0V$		6 45 2.5		$\mu\text{Vp-p}$ $\text{nV}/\sqrt{\text{Hz}}$ $\text{fA}/\sqrt{\text{Hz}}$
<b>OPEN-LOOP GAIN</b> Open-Loop Voltage Gain <b>over Temperature</b> <b>over Temperature</b>	$A_{OL}$ $R_L = 100\text{k}\Omega, (V-) + 0.1V < V_O < (V+) - 0.1V$ $R_L = 20\text{k}\Omega, (V-) + 0.075V < V_O < (V+) - 0.075V$ <b><math>R_L = 20\text{k}\Omega, (V-) + 0.075V &lt; V_O &lt; (V+) - 0.075V</math></b> $R_L = 5\text{k}\Omega, (V-) + 0.15V < V_O < (V+) - 0.15V$ <b><math>R_L = 5\text{k}\Omega, (V-) + 0.15V &lt; V_O &lt; (V+) - 0.15V</math></b>	100 100	120 110 <b>106</b> 110 <b>106</b>		dB dB dB dB dB
<b>OUTPUT</b> Voltage Output Swing from Rail  Output Current Short-Circuit Current Capacitive Load Drive	$I_{OUT}$ $I_{SC}$ $C_{LOAD}$ $R_L = 100\text{k}\Omega, A_{OL} > 80\text{dB}$ $R_L = 20\text{k}\Omega, A_{OL} > 100\text{dB}$ $R_L = 5\text{k}\Omega, A_{OL} > 100\text{dB}$ $ V_S - V_{OUT}  < 1V$		40 $\pm 10$ $\pm 40$	75 150	mV mV mV mA mA
<b>FREQUENCY RESPONSE</b> Gain-Bandwidth Product Slew Rate Settling Time, 0.1% 0.01% Overload Recovery Time Total Harmonic Distortion + Noise	GBW SR $t_s$ $t_s$ THD+N $C_L = 100\text{pF}$ $G = +1$ $V_S = \pm 5V, G = +1$ $V_S = \pm 5V, 5V$ Step, $G = +1$ $V_S = \pm 5V, 5V$ Step, $G = +1$ $V_{IN} \cdot \text{Gain} = V_S$ $V_S = \pm 5V, V_O = 3V_{p-p}, G = +1, f = 1\text{kHz}$		1 0.6 15 20 3 0.02		MHz $\text{V}/\mu\text{s}$ $\mu\text{s}$ $\mu\text{s}$ $\mu\text{s}$ %
<b>POWER SUPPLY</b> Specified Voltage Range, Single Supply Specified Voltage Range, Dual Supplies Operating Voltage Range Quiescent Current (per amplifier) <b>over Temperature</b>	$V_S$ $V_S$ $I_Q$ $I_Q = 0$	4 $\pm 2$	3.6 to 12 160 <b>200</b>	12 $\pm 6$ 250	V V V $\mu\text{A}$ $\mu\text{A}$
<b>TEMPERATURE RANGE</b> Specified Range Operating Range Storage Range Thermal Resistance SOT23-5 Surface-Mount MSOP-8 Surface-Mount TSSOP-14 Surface-Mount SO-8 Surface Mount SO-14 Surface Mount DIP-8	$\theta_{JA}$	-40 -55 -65		85 125 150	$^\circ\text{C}$ $^\circ\text{C}$ $^\circ\text{C}$ $^\circ\text{C}/\text{W}$ $^\circ\text{C}/\text{W}$ $^\circ\text{C}/\text{W}$ $^\circ\text{C}/\text{W}$ $^\circ\text{C}/\text{W}$ $^\circ\text{C}/\text{W}$

# TYPICAL CHARACTERISTICS

At  $T_A = +25^\circ\text{C}$ ,  $V_S = \pm 5\text{V}$ , and  $R_L = 20\text{k}\Omega$ , unless otherwise noted.

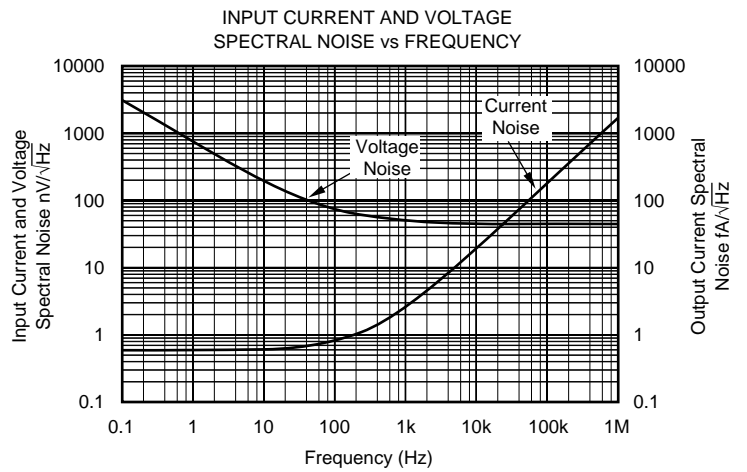
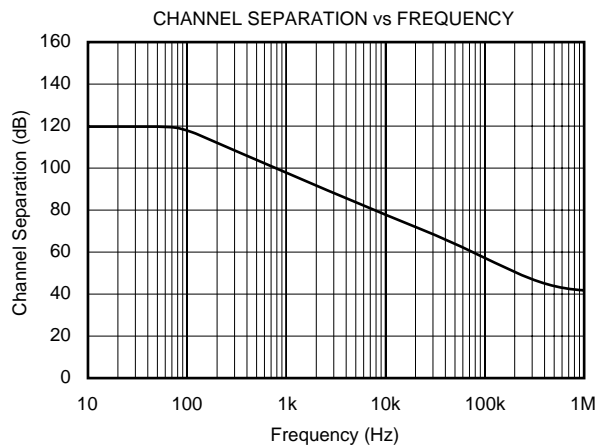
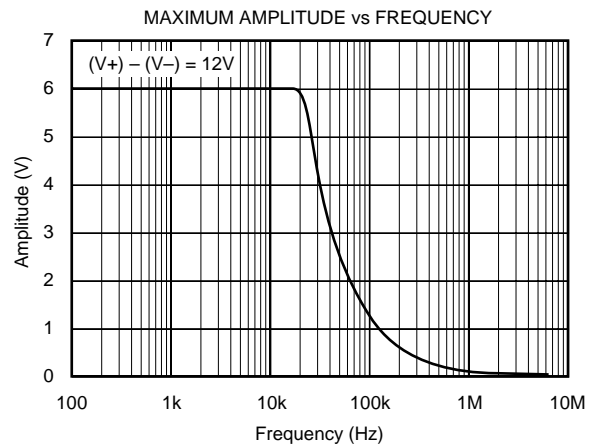
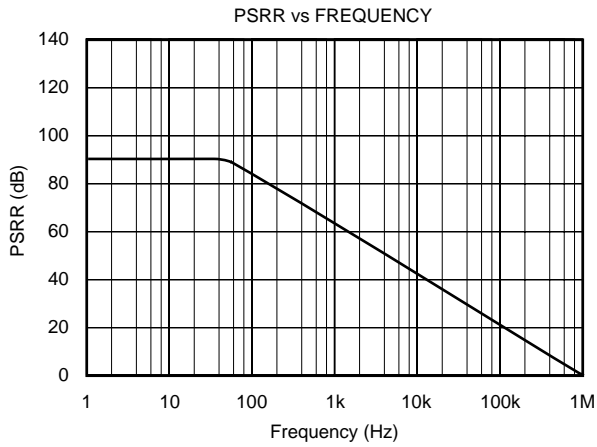
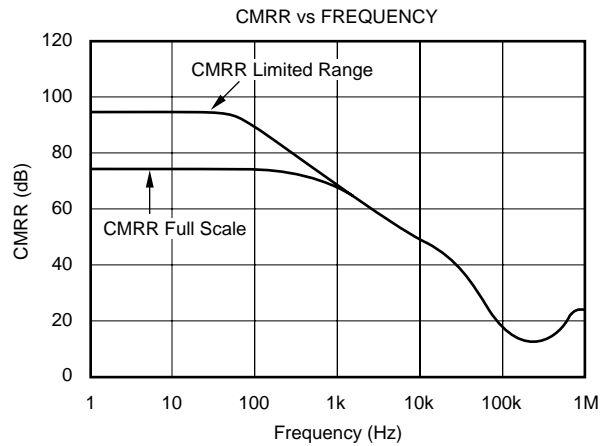
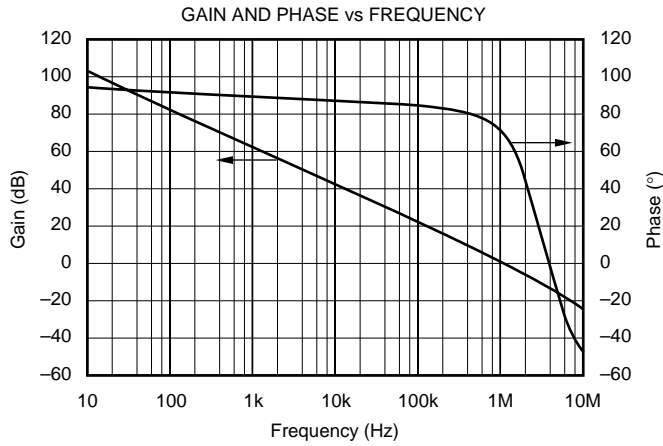

# TYPICAL CHARACTERISTICS (Cont.)

At  $T_A = +25^\circ\text{C}$ ,  $V_S = \pm 5\text{V}$ , and  $R_L = 20\text{k}\Omega$ , unless otherwise noted.

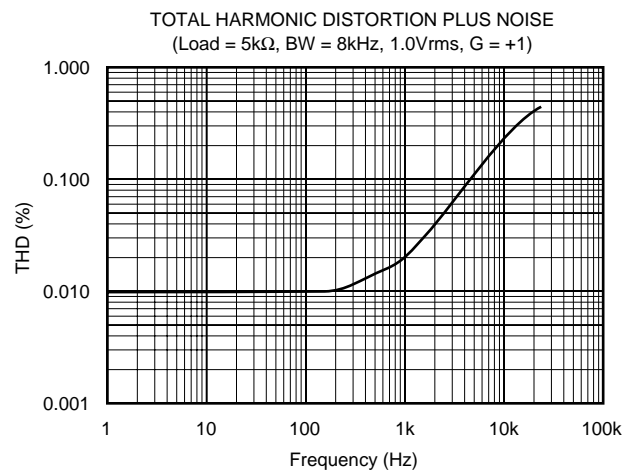
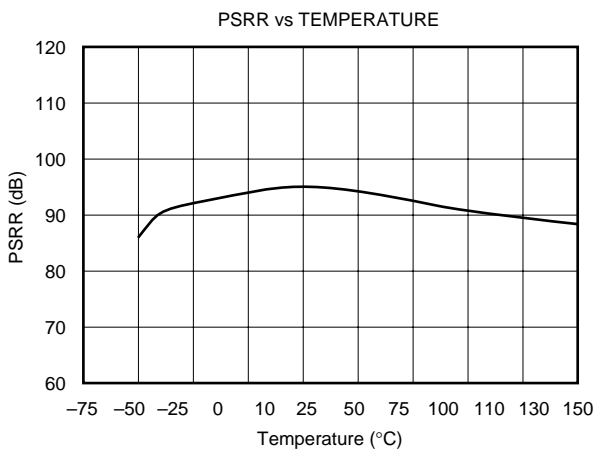
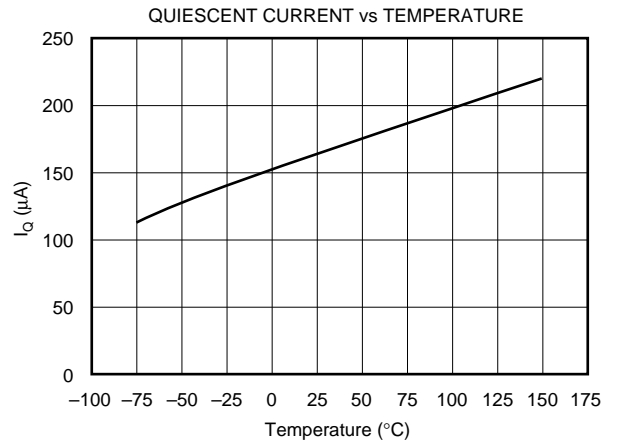
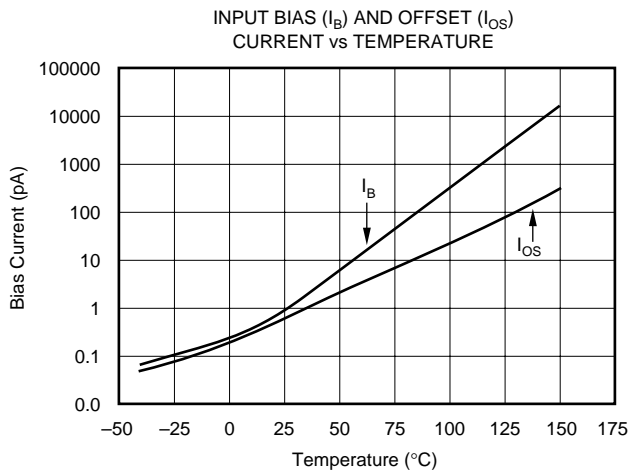
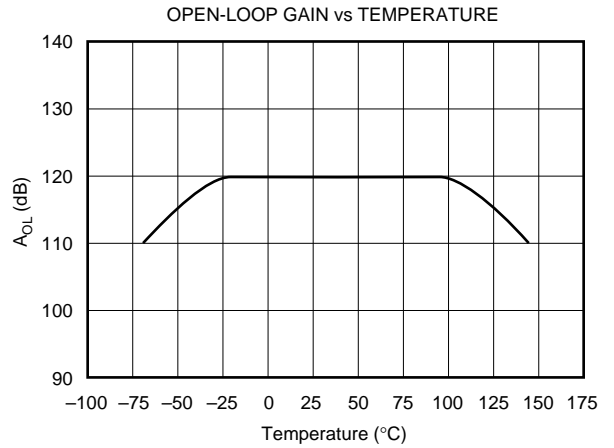
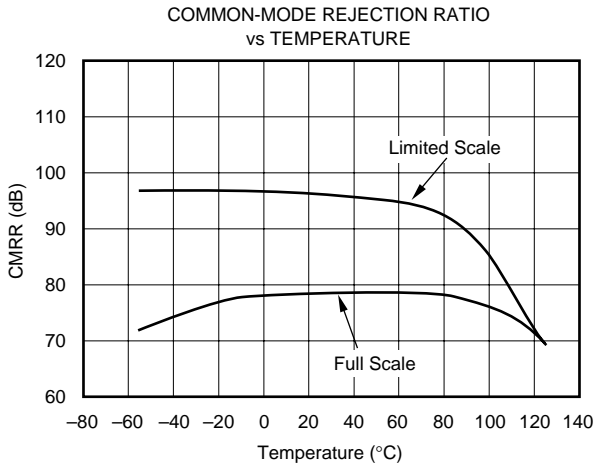

# TYPICAL CHARACTERISTICS (Cont.)

At  $T_A = +25^\circ\text{C}$ ,  $V_S = \pm 5\text{V}$ , and  $R_L = 20\text{k}\Omega$ , unless otherwise noted.

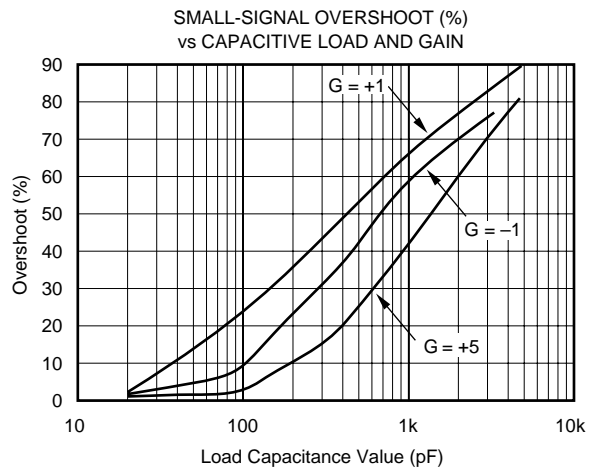
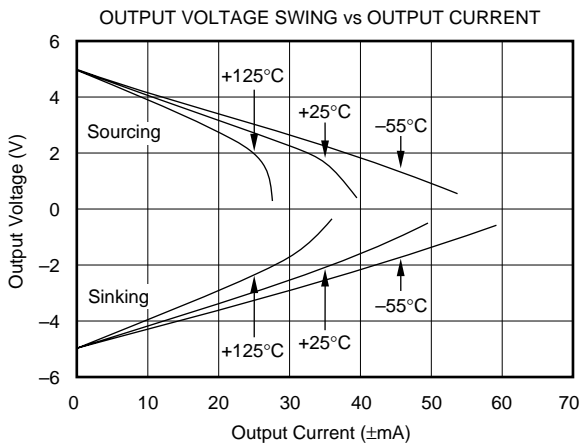
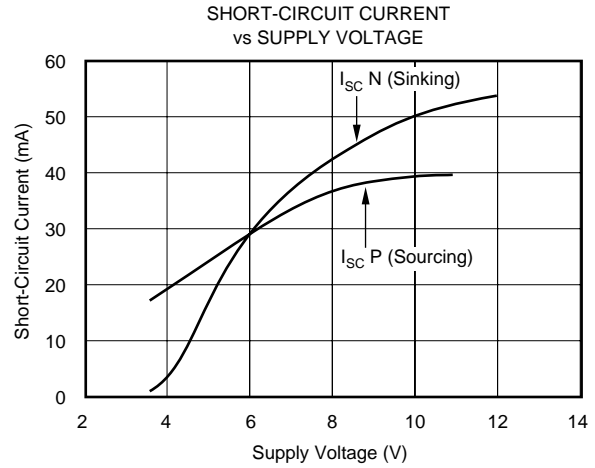
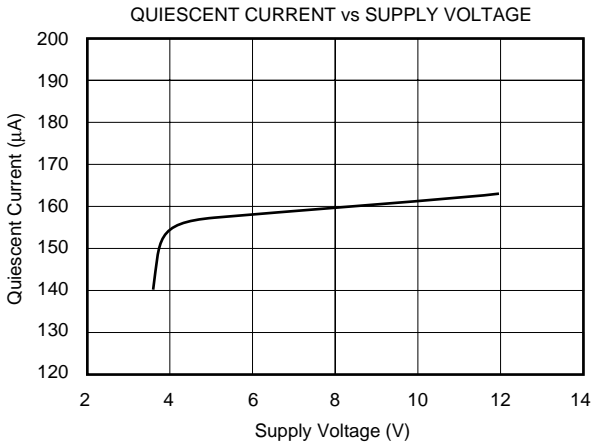
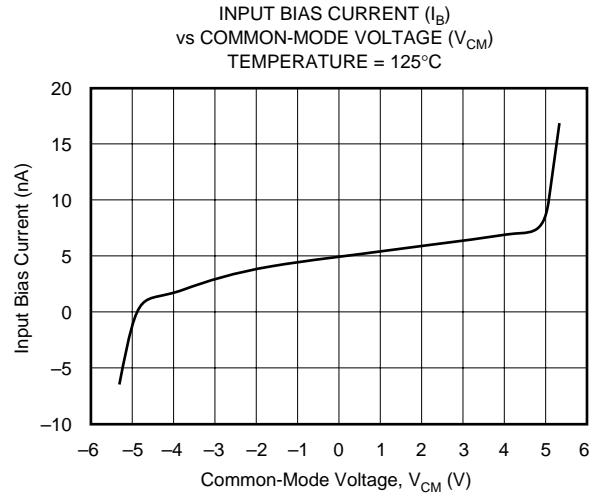
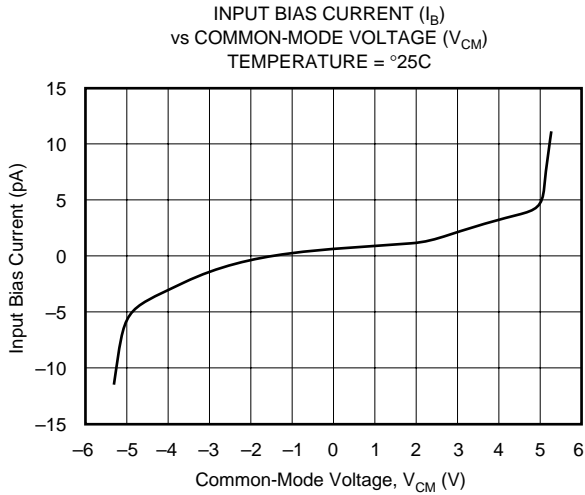

# TYPICAL CHARACTERISTICS (Cont.)

At  $T_A = +25^\circ\text{C}$ ,  $V_S = \pm 5\text{V}$ , and  $R_L = 20\text{k}\Omega$ , unless otherwise noted.

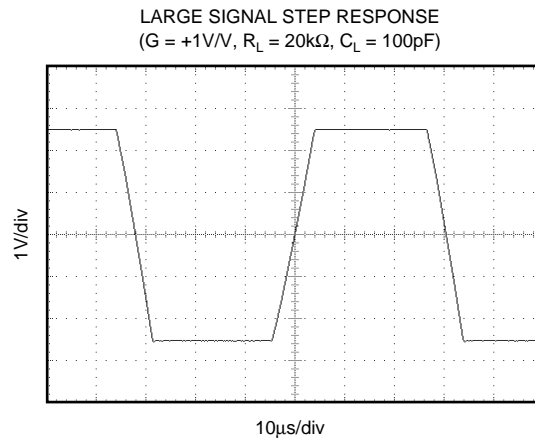
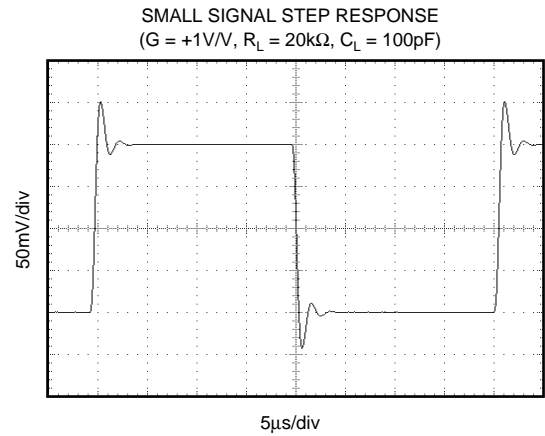
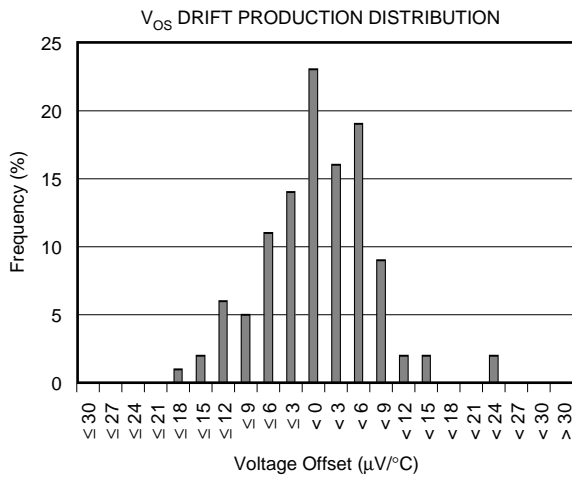
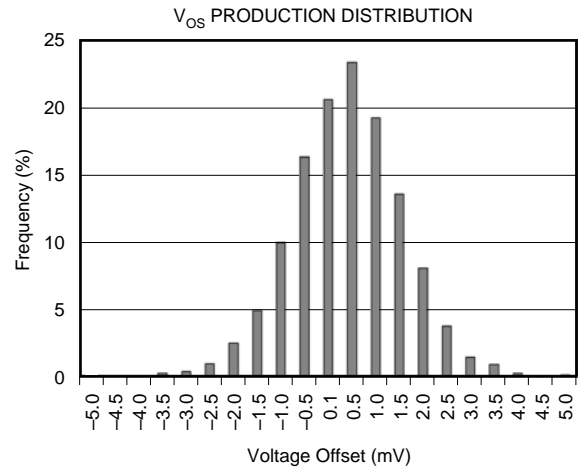
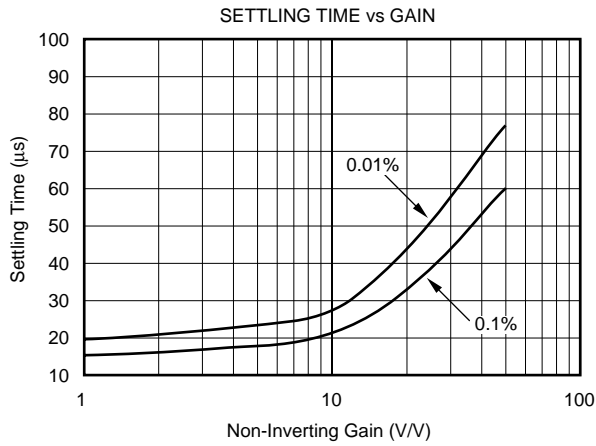

# APPLICATIONS INFORMATION

OPA705 series op amps can operate on 160 $\mu$ A quiescent current from a single (or split) supply in the range of 4V to 12V ( $\pm 2$ V to  $\pm 6$ V), making them highly versatile and easy to use. The OPA705 is unity-gain stable and offers 1MHz bandwidth and 0.6V/ $\mu$ s slew rate.

Rail-to-rail input and output swing helps maintain dynamic range, especially in low supply applications. Figure 1 shows the input and output waveforms for the OPA705 in unity-gain configuration. Operation is from a  $\pm 5$ V supply with a 100k $\Omega$  load connected to  $V_S/2$ . The input is a 10Vp-p sinusoid. Output voltage is approximately 10Vp-p.

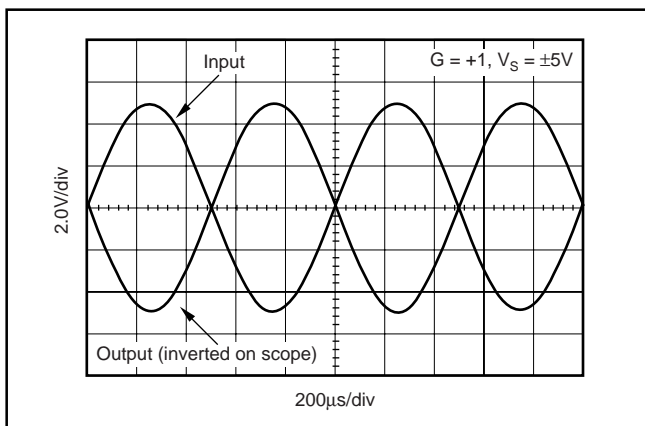

FIGURE 1. Rail-to-Rail Input and Output.

Power-supply pins should be bypassed with 1000pF ceramic capacitors in parallel with 1 $\mu$ F tantalum capacitors.

## OPERATING VOLTAGE

OPA705 series op amps are fully specified and guaranteed from +4V to +12V over a temperature range of  $-40^{\circ}$ C to  $+85^{\circ}$ C. Parameters that vary significantly with operating voltages or temperature are shown in the Typical Characteristics.

## RAIL-TO-RAIL INPUT

The input common-mode voltage range of the OPA705 series extends 300mV beyond the supply rails at room temperature. This is achieved with a complementary input stage—an N-channel input differential pair in parallel with a P-channel differential pair, as shown in Figure 2. The N-channel pair is active for input voltages close to the positive rail, typically  $(V_+) - 2.0$ V to 300mV above the positive supply, while the P-channel pair is on for inputs from 300mV below the negative supply to approximately  $(V_+) - 1.5$ V. There is a small transition region, typically  $(V_+) - 2.0$ V to  $(V_+) - 1.5$ V, in which both pairs are on. This 500mV transition region can vary  $\pm 100$ mV with process variation. Thus, the transition region (both stages on) can range from  $(V_+) - 2.1$ V to  $(V_+) - 1.4$ V on the low end, up to  $(V_+) - 1.9$ V to  $(V_+) - 1.6$ V on the high end. Within the 500mV transition region PSRR, CMRR, offset voltage, and offset drift, and THD may vary compared to operation outside this region.

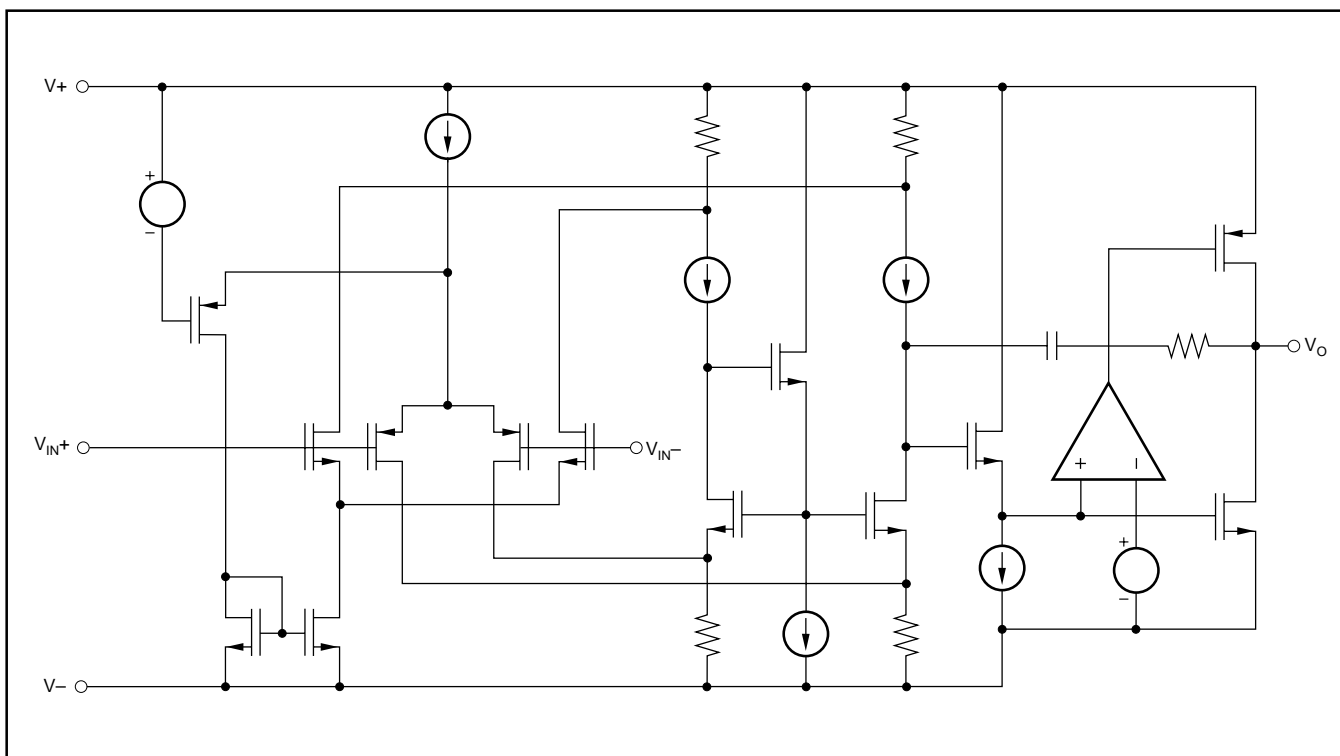

FIGURE 2. Simplified Schematic.



## INPUT VOLTAGE

Device inputs are protected by ESD diodes that will conduct if the input voltages exceed the power supplies by more than approximately 300mV. Momentary voltages greater than 300mV beyond the power supply can be tolerated if the current is limited to 10mA. This is easily accomplished with an input resistor, as shown in Figure 3. Many input signals are inherently current-limited to less than 10mA; therefore, a limiting resistor is not always required. The OPA705 features no phase inversion when the inputs extend beyond supplies if the input current is limited, as seen in Figure 4.

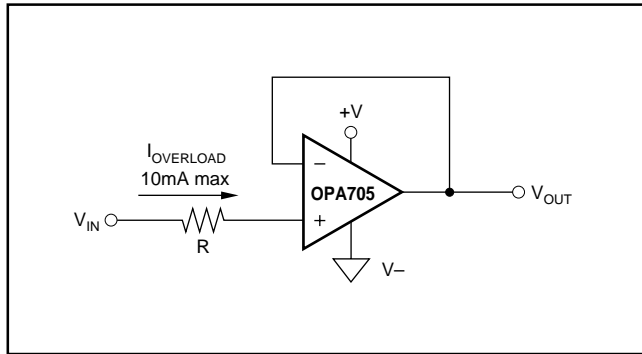

FIGURE 3. Input Current Protection for Voltages Exceeding the Supply Voltage.

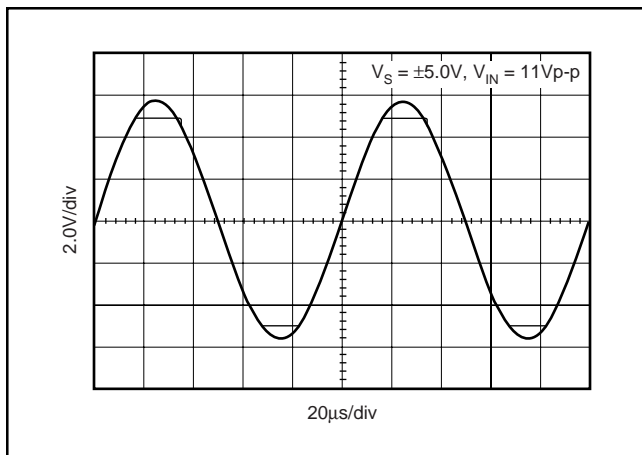

FIGURE 4. OPA705—No Phase Inversion with Inputs Greater than the Power-Supply Voltage.

## RAIL-TO-RAIL OUTPUT

A class AB output stage with common-source transistors is used to achieve rail-to-rail output. This output stage is capable of driving 1kΩ loads connected to any point between V+ and ground. For light resistive loads (> 100kΩ), the output voltage can swing to 40mV from the supply rail. With moderate resistive loads (20kΩ), the output can swing to within 75mV from the supply rails while maintaining high open-loop gain (see the typical performance curve “Output Voltage Swing vs Output Current”).

## CAPACITIVE LOAD AND STABILITY

The OPA705 series op amps can drive up to 1000pF pure capacitive load. Increasing the gain enhances the amplifier’s ability to drive greater capacitive loads (see the typical performance curve “Small Signal Overshoot vs Capacitive Load”).

One method of improving capacitive load drive in the unity-gain configuration is to insert a 10Ω to 20Ω resistor inside the feedback loop, as shown in Figure 5. This reduces ringing with large capacitive loads while maintaining DC accuracy.

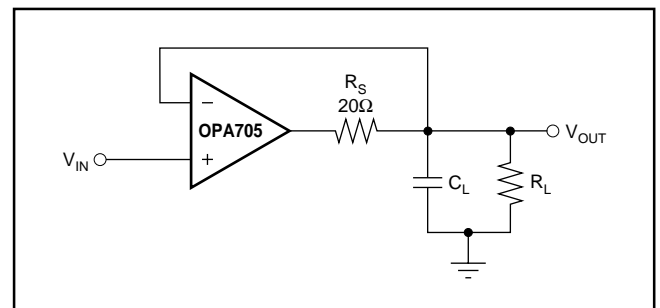

FIGURE 5. Series Resistor in Unity-Gain Buffer Configuration Improves Capacitive Load Drive.

## APPLICATION CIRCUITS

The OPA705 series op amps are optimized for driving medium-speed sampling data converters. Figure 6 shows the OPA2705 in a dual-supply buffered reference configuration for the DAC7644. The DAC7644 is a 16-bit, low-power, quad-voltage output converter. Small size makes the combination ideal for automatic test equipment, data acquisition systems, and other low-power space-limited applications.

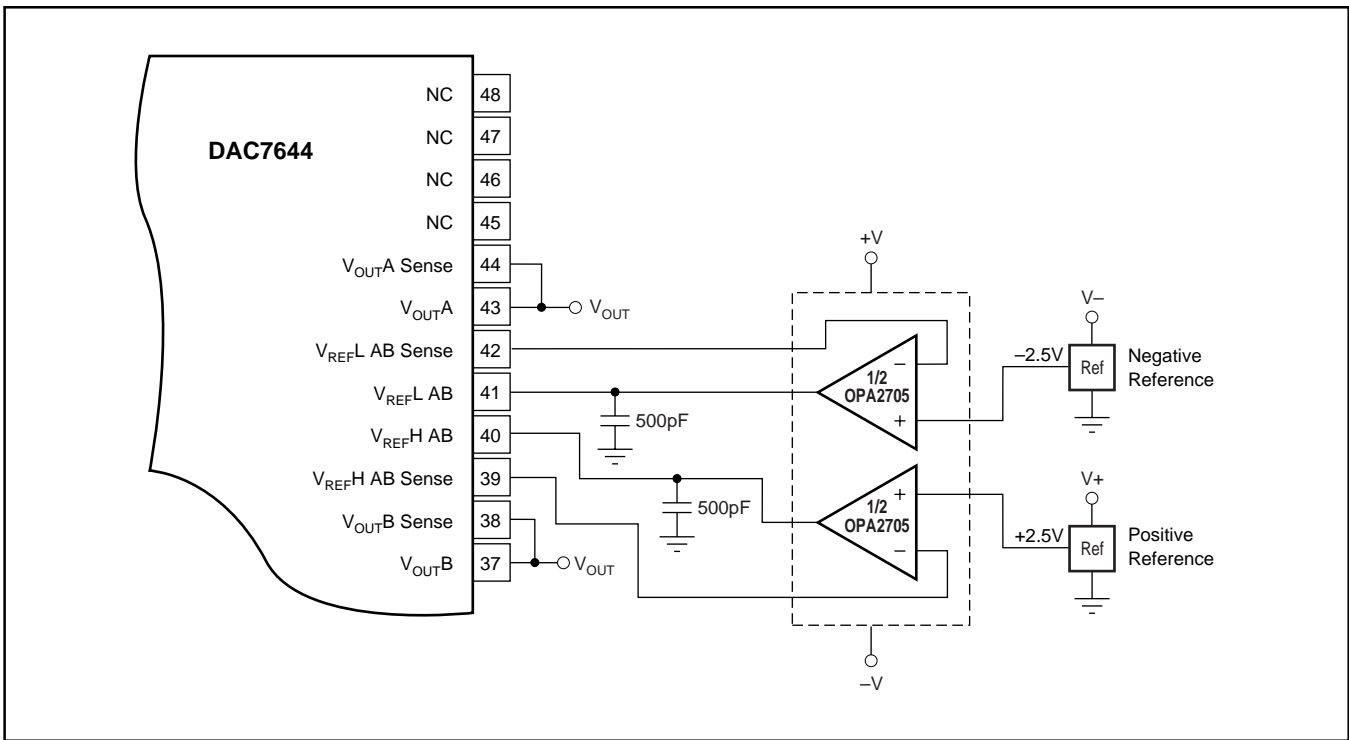

FIGURE 6. OPA705 as Dual Supply Configuration-Buffered References for the DAC7644.

**PACKAGING INFORMATION**

Orderable Device	Status <sup>(1)</sup>	Package Type	Package Drawing	Pins	Package Qty	Eco Plan <sup>(2)</sup>	Lead/Ball Finish	MSL Peak Temp <sup>(3)</sup>
OPA2705EA/250	ACTIVE	MSOP	DGK	8	250	Green (RoHS & no Sb/Br)	CU NIPDAU	Level-2-260C-1 YEAR
OPA2705EA/250G4	ACTIVE	MSOP	DGK	8	250	Green (RoHS & no Sb/Br)	CU NIPDAU	Level-2-260C-1 YEAR
OPA2705PA	ACTIVE	PDIP	P	8	50	Green (RoHS & no Sb/Br)	CU NIPDAU	N / A for Pkg Type
OPA2705PAG4	ACTIVE	PDIP	P	8	50	Green (RoHS & no Sb/Br)	CU NIPDAU	N / A for Pkg Type
OPA2705UA	ACTIVE	SOIC	D	8	100	Green (RoHS & no Sb/Br)	CU NIPDAU	Level-2-260C-1 YEAR
OPA2705UAG4	ACTIVE	SOIC	D	8	100	Green (RoHS & no Sb/Br)	CU NIPDAU	Level-2-260C-1 YEAR
OPA4705EA/250	ACTIVE	TSSOP	PW	14	250	Green (RoHS & no Sb/Br)	CU NIPDAU	Level-2-260C-1 YEAR
OPA4705EA/250G4	ACTIVE	TSSOP	PW	14	250	Green (RoHS & no Sb/Br)	CU NIPDAU	Level-2-260C-1 YEAR
OPA4705EA/2K5	ACTIVE	TSSOP	PW	14	2500	Green (RoHS & no Sb/Br)	CU NIPDAU	Level-2-260C-1 YEAR
OPA4705EA/2K5G4	ACTIVE	TSSOP	PW	14	2500	Green (RoHS & no Sb/Br)	CU NIPDAU	Level-2-260C-1 YEAR
OPA4705UA	ACTIVE	SOIC	D	14	58	Green (RoHS & no Sb/Br)	CU NIPDAU	Level-2-260C-1 YEAR
OPA4705UAG4	ACTIVE	SOIC	D	14	58	Green (RoHS & no Sb/Br)	CU NIPDAU	Level-2-260C-1 YEAR
OPA705NA/250	ACTIVE	SOT-23	DBV	5	250	Green (RoHS & no Sb/Br)	CU NIPDAU	Level-2-260C-1 YEAR
OPA705NA/250G4	ACTIVE	SOT-23	DBV	5	250	Green (RoHS & no Sb/Br)	CU NIPDAU	Level-2-260C-1 YEAR
OPA705NA/3K	ACTIVE	SOT-23	DBV	5	3000	Green (RoHS & no Sb/Br)	CU NIPDAU	Level-2-260C-1 YEAR
OPA705NA/3KG4	ACTIVE	SOT-23	DBV	5	3000	Green (RoHS & no Sb/Br)	CU NIPDAU	Level-2-260C-1 YEAR
OPA705PA	ACTIVE	PDIP	P	8	50	Green (RoHS & no Sb/Br)	CU NIPDAU	N / A for Pkg Type
OPA705PAG4	ACTIVE	PDIP	P	8	50	Green (RoHS & no Sb/Br)	CU NIPDAU	N / A for Pkg Type
OPA705UA	ACTIVE	SOIC	D	8	100	Green (RoHS & no Sb/Br)	CU NIPDAU	Level-2-260C-1 YEAR
OPA705UAG4	ACTIVE	SOIC	D	8	100	Green (RoHS & no Sb/Br)	CU NIPDAU	Level-2-260C-1 YEAR

<sup>(1)</sup> The marketing status values are defined as follows:

**ACTIVE:** Product device recommended for new designs.

**LIFEBUY:** TI has announced that the device will be discontinued, and a lifetime-buy period is in effect.

**NRND:** Not recommended for new designs. Device is in production to support existing customers, but TI does not recommend using this part in a new design.

**PREVIEW:** Device has been announced but is not in production. Samples may or may not be available.

**OBsolete:** TI has discontinued the production of the device.

<sup>(2)</sup> Eco Plan - The planned eco-friendly classification: Pb-Free (RoHS), Pb-Free (RoHS Exempt), or Green (RoHS & no Sb/Br) - please check <http://www.ti.com/productcontent> for the latest availability information and additional product content details.

**TBD:** The Pb-Free/Green conversion plan has not been defined.

**Pb-Free (RoHS):** TI's terms "Lead-Free" or "Pb-Free" mean semiconductor products that are compatible with the current RoHS requirements for all 6 substances, including the requirement that lead not exceed 0.1% by weight in homogeneous materials. Where designed to be soldered at high temperatures, TI Pb-Free products are suitable for use in specified lead-free processes.

**Pb-Free (RoHS Exempt):** This component has a RoHS exemption for either 1) lead-based flip-chip solder bumps used between the die and package, or 2) lead-based die adhesive used between the die and leadframe. The component is otherwise considered Pb-Free (RoHS compatible) as defined above.

**Green (RoHS & no Sb/Br):** TI defines "Green" to mean Pb-Free (RoHS compatible), and free of Bromine (Br) and Antimony (Sb) based flame retardants (Br or Sb do not exceed 0.1% by weight in homogeneous material)

<sup>(3)</sup> MSL, Peak Temp. -- The Moisture Sensitivity Level rating according to the JEDEC industry standard classifications, and peak solder temperature.

**Important Information and Disclaimer:**The information provided on this page represents TI's knowledge and belief as of the date that it is provided. TI bases its knowledge and belief on information provided by third parties, and makes no representation or warranty as to the accuracy of such information. Efforts are underway to better integrate information from third parties. TI has taken and continues to take reasonable steps to provide representative and accurate information but may not have conducted destructive testing or chemical analysis on incoming materials and chemicals. TI and TI suppliers consider certain information to be proprietary, and thus CAS numbers and other limited information may not be available for release.

In no event shall TI's liability arising out of such information exceed the total purchase price of the TI part(s) at issue in this document sold by TI to Customer on an annual basis.

**TAPE AND REEL INFORMATION**

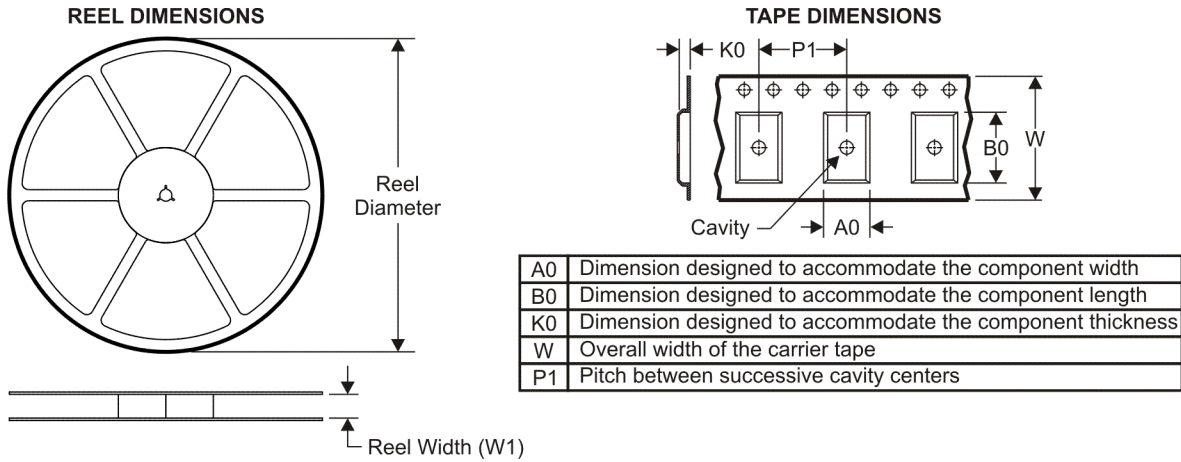

**QUADRANT ASSIGNMENTS FOR PIN 1 ORIENTATION IN TAPE**



\*All dimensions are nominal

Device	Package Type	Package Drawing	Pins	SPQ	Reel Diameter (mm)	Reel Width W1 (mm)	A0 (mm)	B0 (mm)	K0 (mm)	P1 (mm)	W (mm)	Pin1 Quadrant
OPA2705EA/250	MSOP	DGK	8	250	180.0	12.4	5.3	3.4	1.4	8.0	12.0	Q1
OPA4705EA/250	TSSOP	PW	14	250	180.0	12.4	7.0	5.6	1.6	8.0	12.0	Q1
OPA4705EA/2K5	TSSOP	PW	14	2500	330.0	12.4	7.0	5.6	1.6	8.0	12.0	Q1
OPA705NA/250	SOT-23	DBV	5	250	180.0	8.4	3.23	3.17	1.37	4.0	8.0	Q3
OPA705NA/3K	SOT-23	DBV	5	3000	180.0	8.4	3.23	3.17	1.37	4.0	8.0	Q3

**TAPE AND REEL BOX DIMENSIONS**



\*All dimensions are nominal

Device	Package Type	Package Drawing	Pins	SPQ	Length (mm)	Width (mm)	Height (mm)
OPA2705EA/250	MSOP	DGK	8	250	184.0	184.0	50.0
OPA4705EA/250	TSSOP	PW	14	250	190.5	212.7	31.8
OPA4705EA/2K5	TSSOP	PW	14	2500	346.0	346.0	29.0
OPA705NA/250	SOT-23	DBV	5	250	214.0	199.0	55.0
OPA705NA/3K	SOT-23	DBV	5	3000	214.0	199.0	55.0

## IMPORTANT NOTICE

Texas Instruments Incorporated and its subsidiaries (TI) reserve the right to make corrections, modifications, enhancements, improvements, and other changes to its products and services at any time and to discontinue any product or service without notice. Customers should obtain the latest relevant information before placing orders and should verify that such information is current and complete. All products are sold subject to TI's terms and conditions of sale supplied at the time of order acknowledgment.

TI warrants performance of its hardware products to the specifications applicable at the time of sale in accordance with TI's standard warranty. Testing and other quality control techniques are used to the extent TI deems necessary to support this warranty. Except where mandated by government requirements, testing of all parameters of each product is not necessarily performed.

TI assumes no liability for applications assistance or customer product design. Customers are responsible for their products and applications using TI components. To minimize the risks associated with customer products and applications, customers should provide adequate design and operating safeguards.

TI does not warrant or represent that any license, either express or implied, is granted under any TI patent right, copyright, mask work right, or other TI intellectual property right relating to any combination, machine, or process in which TI products or services are used. Information published by TI regarding third-party products or services does not constitute a license from TI to use such products or services or a warranty or endorsement thereof. Use of such information may require a license from a third party under the patents or other intellectual property of the third party, or a license from TI under the patents or other intellectual property of TI.

Reproduction of TI information in TI data books or data sheets is permissible only if reproduction is without alteration and is accompanied by all associated warranties, conditions, limitations, and notices. Reproduction of this information with alteration is an unfair and deceptive business practice. TI is not responsible or liable for such altered documentation. Information of third parties may be subject to additional restrictions.

Resale of TI products or services with statements different from or beyond the parameters stated by TI for that product or service voids all express and any implied warranties for the associated TI product or service and is an unfair and deceptive business practice. TI is not responsible or liable for any such statements.

TI products are not authorized for use in safety-critical applications (such as life support) where a failure of the TI product would reasonably be expected to cause severe personal injury or death, unless officers of the parties have executed an agreement specifically governing such use. Buyers represent that they have all necessary expertise in the safety and regulatory ramifications of their applications, and acknowledge and agree that they are solely responsible for all legal, regulatory and safety-related requirements concerning their products and any use of TI products in such safety-critical applications, notwithstanding any applications-related information or support that may be provided by TI. Further, Buyers must fully indemnify TI and its representatives against any damages arising out of the use of TI products in such safety-critical applications.

TI products are neither designed nor intended for use in military/aerospace applications or environments unless the TI products are specifically designated by TI as military-grade or "enhanced plastic." Only products designated by TI as military-grade meet military specifications. Buyers acknowledge and agree that any such use of TI products which TI has not designated as military-grade is solely at the Buyer's risk, and that they are solely responsible for compliance with all legal and regulatory requirements in connection with such use.

TI products are neither designed nor intended for use in automotive applications or environments unless the specific TI products are designated by TI as compliant with ISO/TS 16949 requirements. Buyers acknowledge and agree that, if they use any non-designated products in automotive applications, TI will not be responsible for any failure to meet such requirements.

Following are URLs where you can obtain information on other Texas Instruments products and application solutions:

### Products

Amplifiers	<a href="http://amplifier.ti.com">amplifier.ti.com</a>
Data Converters	<a href="http://dataconverter.ti.com">dataconverter.ti.com</a>
DSP	<a href="http://dsp.ti.com">dsp.ti.com</a>
Clocks and Timers	<a href="http://www.ti.com/clocks">www.ti.com/clocks</a>
Interface	<a href="http://interface.ti.com">interface.ti.com</a>
Logic	<a href="http://logic.ti.com">logic.ti.com</a>
Power Mgmt	<a href="http://power.ti.com">power.ti.com</a>
Microcontrollers	<a href="http://microcontroller.ti.com">microcontroller.ti.com</a>
RFID	<a href="http://www.ti-rfid.com">www.ti-rfid.com</a>
RF/IF and ZigBee® Solutions	<a href="http://www.ti.com/lprf">www.ti.com/lprf</a>

### Applications

Audio	<a href="http://www.ti.com/audio">www.ti.com/audio</a>
Automotive	<a href="http://www.ti.com/automotive">www.ti.com/automotive</a>
Broadband	<a href="http://www.ti.com/broadband">www.ti.com/broadband</a>
Digital Control	<a href="http://www.ti.com/digitalcontrol">www.ti.com/digitalcontrol</a>
Medical	<a href="http://www.ti.com/medical">www.ti.com/medical</a>
Military	<a href="http://www.ti.com/military">www.ti.com/military</a>
Optical Networking	<a href="http://www.ti.com/opticalnetwork">www.ti.com/opticalnetwork</a>
Security	<a href="http://www.ti.com/security">www.ti.com/security</a>
Telephony	<a href="http://www.ti.com/telephony">www.ti.com/telephony</a>
Video & Imaging	<a href="http://www.ti.com/video">www.ti.com/video</a>
Wireless	<a href="http://www.ti.com/wireless">www.ti.com/wireless</a>

Mailing Address: Texas Instruments, Post Office Box 655303, Dallas, Texas 75265  
Copyright © 2008, Texas Instruments Incorporated